

BAYERISCHE AKADEMIE DER WISSENSCHAFTEN
MATHEMATISCH-NATURWISSENSCHAFTLICHE KLASSE

SITZUNGSBERICHTE

JAHRGANG

1993

MÜNCHEN 1994

VERLAG DER BAYERISCHEN AKADEMIE DER WISSENSCHAFTEN
In Kommission bei der C. H. Beck'schen Verlagsbuchhandlung München

Physics of directional hearing in crickets

by Axel Michelsen

Institute of Biology, Odense University, DK-5230 Odense M, Denmark

Introduction

Man and most large animals can use two mechanisms for detecting the direction of sound incidence: the interaural difference in sound pressure caused by diffraction of sound by the body, and the difference in time of arrival of the sound at the two ears. Differences in sound pressure arise when the dimensions of the body (head) are above one-tenth of the wavelength of the sound. The frequency spectrum at each ear varies with the angle of sound incidence, and the spectra at the two ears are different for most directions. It is thus possible for the brain to estimate the direction to the sound source by comparing the sound spectra at the two ears. Obviously, this task is easier with broad-band sounds than with pure tones or narrow-band sounds.

Sound travels in air with a velocity of ca. 344 m/s. In humans (head diameter ca. 17 cm), the maximum difference in the time of arrival at the ears is ca. 0.5 ms. We can localize long pure tones below ca. 1,400 Hz by means of this mechanism, since there is a cycle-by-cycle following of the sound wave by the nerve impulses (phase detection). At higher frequencies, the time of arrival can be detected if the sound is sufficiently modulated in amplitude or frequency content.

So far, we have not defined a "large" animal. The possible use of diffraction is not determined by the absolute size of the animal, but by its size relative to the wavelength of the sounds to be heard. For example, in moths exposed to the ultrasonic cries of bats, the two ears may experience a pressure difference of 10–20 dB (and even 30–40 dB in very large moths), which is more than sufficient for the purpose of determining the direction to the bat (Payne, Roeder and Wallman 1966).

A similar situation appears to exist in many bush crickets (*Tettigoniidae*). The ears are in the thin front legs far away from the body surface. Diffraction does not (even at very high frequencies) provide a sufficient difference in the sound pressures at the external surfaces of the two ears. The bush crickets' solution is to use a horn-shaped tracheal tube (a "hearing trumpet") for transmitting sound to the ear from the surface of the body, where diffraction is causing much larger directional cues (Michelsen et al 1993a). The calling songs are typically carried by a broad band of frequencies above 10 kHz, where the hearing trumpet may have a gain of 5–10 times. The sound carried by the hearing trumpet therefore dominates the ear (i. e., the ear drum is driven by the sound pressure at its inner surface, and the sound at the outer surface does not play a significant role). The ears thus obtain the same (diffraction-based) directionality as if they had been situated at the surface of the body. As we shall see, although the ears of crickets and bush crickets have many anatomical features in common (and a common evolutionary origin), they have exploited two widely different mechanisms for directional hearing.

The situation in small animals

In many hearing animals (e. g., insects, frogs, birds) the part of the body carrying the ears is 10 to 50 times smaller than the human head. A difference in the sound pressure at the two ears is available only at very high frequencies. For example, the wavelength of the calling song of many crickets and frogs is 5–10 times larger than the animal's body, and only little difference in pressure is found at the ears during the calling song.

Insects and other arthropods (spiders, scorpions) are able to process information about the onset of excitation in some of their sense organs. Spiders and scorpions receive vibrational signals through their legs, and they will turn to the side from which they first receive a stimulus (Hergentröder and Barth 1983; Brownell and Farley 1979). Time differences of 0.2–1 ms are necessary, and these values correspond to those expected from the size of the animals and the propagation velocity of the signals. A male grasshopper listening to female song transmitted by two loudspeakers placed to its left and right side will likewise turn to the side of the earlier signal when the songs are

time shifted by 0.5–1 ms (von Helversen and von Helversen 1983). However, the maximum time difference expected when the grasshoppers are locating each other is only 20–30 μ s, and there is no evidence that the insect central nervous system can use such small time differences as directional cues.

Most small animals are obviously unable to determine the direction of sound by means of these two mechanisms. The solutions to this problem were first realized by Autrum (1940), who pointed out that the direction of sound waves is estimated by insects either by means of pressure difference receivers or by means of movement receivers.

One obvious solution is to measure the direction of the oscillatory movements of the air particles. Insects do this by means of long, lightly articulated sensory hairs protruding from their body surface. Such movement receivers are inherently directional. In addition, their shape, articulation and the attachment of the sensory cell(s) may all contribute to the directionality (Tautz 1979). The main disadvantage of such hairs is their modest sensitivity in acoustic far fields. However, the movement component of sound increases more than does the pressure component when one approaches a sound source, and at close range the hairs may be as sensitive as pressure receivers or pressure difference receivers.

Pressure difference receivers

In a pressure difference (pressure gradient) receiver, the sound waves reach both surfaces on the ear drum (tympanal membrane). In theory, this is possible in many animals, since the ears are often connected by an air-filled passage. Alternatively, the sound waves may enter the body and reach the inner surface of the tympanal membrane through some other route (e.g., a tracheal tube). Such potentially sound-transmitting pathways are known in several insect groups and in some frogs, reptiles, birds and even mammals. In most cases, various experimental evidence supports the notion that these ears function as pressure difference receivers (Lewis 1983). However, a proper physical analysis has to far been performed only in the cricket (Michelsen et al 1993b).

The existence of an anatomical air space leading to the inner surface of the tympanum is a necessary prerequisite, but it does not automa-

tically create a pressure difference receiver with proper directionality. The sound has to arrive at the inner surface of the membrane with a proper amplitude and phase. In addition, the sound inside the animal should be affected in a suitable manner by the direction from which the sound reaches the outer surface of the animal. One complicating factor in the analysis is that the sound arriving at the inner surface may have entered the body through several auditory inputs (for example, through the other ear and through two spiracles in crickets; through the other ear and through the lung in frogs).

The transmission of the sound to the inner surface of the tympanum is often a function of frequency. In locusts (Michelsen 1971) and some birds (Hill et al 1980) low-frequency sound is transmitted from one ear to the other with little attenuation. High-frequency sounds are attenuated, however, and the ear becomes a pressure receiver. In most animals the ears are at the surface of the head or body, and at high frequencies diffraction causes a difference in the sound pressure at the ears that is sufficient to provide a reliable directional cue.

The air space leading to the back surface of the tympanum is often a part of (or connected to) the respiratory pathways. This may have undesirable consequences, since the large pressure fluctuations during respiration may affect the ears. In grasshoppers the tympana may be displaced outside their linear range (so that Hooke's law is no longer obeyed). This may affect the threshold for hearing and seriously distort the frequency analysis (Michelsen et al 1990). Large displacements coupled with the respiration can also be observed in frogs (in which the middle ear cavity and the mouth are connected through a wide Eustachian tube). Obviously, a reduction of such effects may have been an important factor in the evolution of pressure difference receivers. The air-filled spongy bone connecting the middle ears in birds, moles and some reptiles would appear to be ideal in this respect.

The cricket ear

In contrast to many bush crickets, the crickets (*Gryllidae*) generally communicate at sonic frequencies, and their calling song is often a pure tone of ca. 5 kHz. Like the bush crickets, the crickets have their

ears in the front leg tibiae (Fig. 1), where diffraction does not provide useful directional cues. However, the crickets have solved the problem in a very different way. A pressure difference receiver mechanism provides the ear with an excellent directionality, especially at frequencies close to that of the calling song.

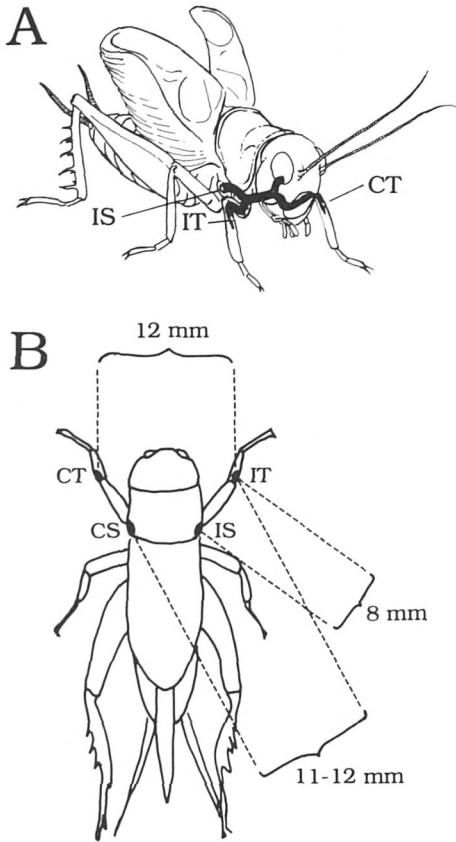

Fig. 1. A. A schematic diagram of the hearing organ of the cricket with an indication of the position of the tympanum and the acoustic spiracle at each side of the body. B. Approximate distances between the acoustic inputs during the measurements of diffraction, time delays and tympanal vibrations. IT and CT, ipsi- and contralateral tympana. IS and CS, ipsi- and contralateral acoustic spiracles.

The internal surface of the tympanum is connected with the ipsilateral acoustic spiracle (IS) on the thorax through a hornshaped tra-

cheal tube known as the acoustic trachea (Fig. 1). The acoustic trachea is also linked, through a connecting trachea, with the acoustic trachea on the other side of the body. Therefore, sound may propagate from the contralateral ear and acoustic spiracle, across the midline, to the inner surface of the ipsilateral tympanum.

However, very different opinions are held of the importance of these contralateral inputs for creating the directional characteristics of the ear. Some investigators have favoured the sound from the contralateral ear (Hill and Boyan 1976, Fletcher and Thwaites 1979), while others favoured the sound from the contralateral spiracle (Larsen and Michelsen 1978, Schmitz et al 1983). Finally, the observation that disrupting the central tracheal connection does not hinder sound localization (in very homogeneous sound fields) has been used as evidence to "toll the death of all such cross-body theories" (Weber and Thorson 1989).

Recently, we have determined the transmission gains of the three internal sound pathways in the cricket *Gryllus bimaculatus* (Michelsen et al 1993b). The transmission gain is the change of the amplitude and phase angle of the sound from the entrance of the tracheal system to the inner surface of the tympanum. In addition, at various directions of sound incidence we have measured the diffraction and time of arrival of sound at the ear and at the three entrances. By combining these data we have calculated how the total driving force at the tympanum depends on the direction of sound. The results are in reasonable agreement with the dependence on sound direction of the tympanal vibrations (as determined with laser vibrometry). The following sections describe some of the results in more detail.

Diffraction and time delays.

The effects of diffraction can be studied in various ways. Klein-dienst (1978) measured the amplitude and phase angle of the sound at various angles of sound incidence in a homogeneous, free sound field before and after the introduction of the body of a cricket. At 5 kHz (the frequency of the calling song), very moderate changes of amplitude and phase were observed, both at the tympanum and the thoracic spiracle (the opening of the acoustic trachea). These results were the true values for the effect of diffraction, but unfortunately they

could not be used for calculations of the forces acting on the tympanum at various directions of sound incidence.

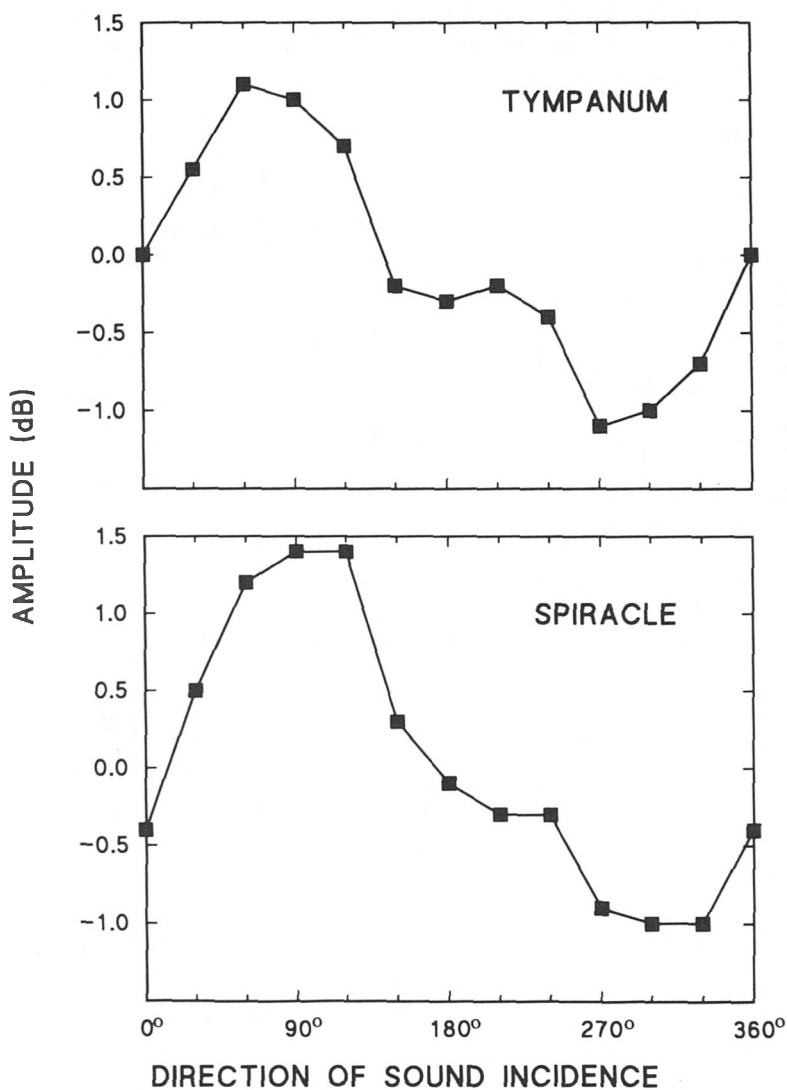

Fig. 2. The amplitude of sound pressure at the tympana and acoustic spiracles at 4.5 kHz and as a function of the angle of sound incidence. 0 dB is defined as the sound pressure at the external surface of the tympanum when sound arrives from the frontal direction (0°). 90° is the ipsilateral direction (cf. Fig. 8, where ipsilateral is to the right).

Our approach was different. We also measured the amplitude and phase angle of the sounds at each of the four auditory inputs at various angles of sound incidence. However, our reference values were not those in an undisturbed sound field, but the values measured at the outer surface of the right ear when sound arrived from the

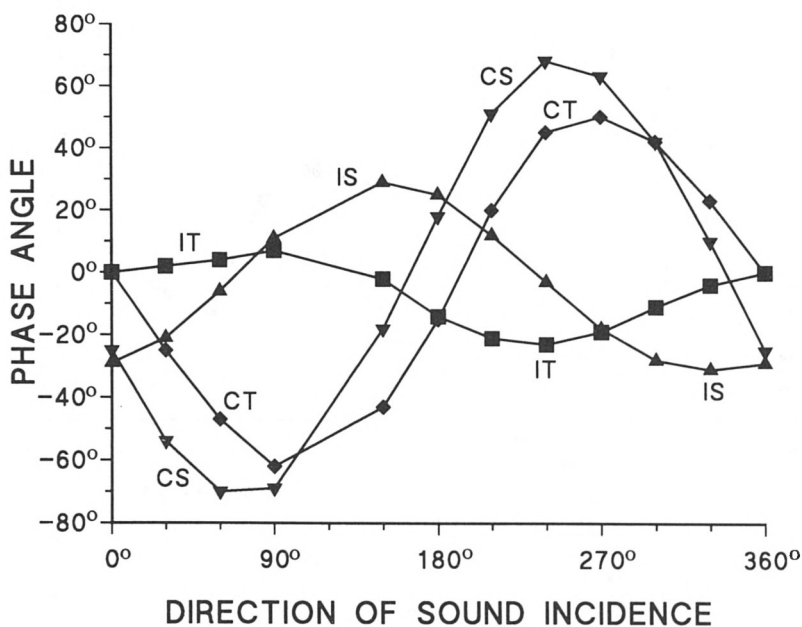

Fig. 3. Phase angles for 4.5 kHz sound at the four acoustic inputs. The phase includes the effects of diffraction and differences in the time of sound arrival (cf. Fig. 1B). 0° phase angle is defined as the phase of the sound at the external surface of the right tympanum when sound arrives from the frontal direction.

frontal direction. In this manner we obtained values, which were not true values for the effects of diffraction, but those needed in the calculations of directionality. The dependence of sound amplitude on sound direction measured in our study (Fig. 2) were quite close to the values observed by Kleindienst. In contrast, the phase angles were very different (Fig. 3), since they were not only caused by diffraction, but also (and mainly) by the different times of arrival of sound at the four auditory inputs. Only in the case of the ipsilateral tympanum itself do our phase values correspond to those of Kleindienst.

From the data in Figs. 2 and 3 one can make some predictions about the mechanism of directional hearing. Let us begin with a cricket, in which the ears are simple pressure receivers, responding only to the pressure at the outer surface of the tympanum. From Fig. 2 it is obvious that the amplitude of the sound pressure at the outer surface of the tympanum changes only little with the direction of sound incidence. In the frontal directions (around 0°), which are of prime interest with respect to localization of a sound source, a change of 30° in sound direction would cause the forces driving the two ears to differ by only 1.3 dB (compare the values at 30° and 330°). This difference may be sufficient for a cricket locating a sound source in a very uniform sound field in the laboratory, but not in the field where the sound field is generally not very uniform.

A pressure difference receiver is obviously needed for providing more directionality, but from which input should the sound at the inner surface of the tympanum originate? Let us consider a cricket in which the sound at the inner surface comes exclusively from the ipsilateral spiracle (IS). Furthermore, let us make the favourable assumption that the sound amplitude at the two surfaces are almost equal in amplitude. From Fig. 2 we find that, although the amplitudes do change as a function of sound direction, the changes are in the same direction (compare the sound amplitudes at the tympanum and spiracle at 0° , 30° , and 330°). Obviously, the amplitude cue is even smaller than in the case of the two pressure receivers. The phase cue (Fig. 3) follows a similar pattern: the phase angles increase at both inputs when the sound direction changes from 0° to 30° and decrease from 0° to 330° . The difference in phase between the sounds at the inner and outer surfaces of the tympanum change by only 5° and 2° , respectively. Such small phase changes can cause a directional dependence of the tympanal vibration, but only if the driving force is close to zero (approximately the same phase at the inner and outer surface), a situation which would hardly be useful for the animal. In conclusion, *even a well-balanced pressure difference receiver does not always provide a useful directionality!*

The sounds arriving from the two contralateral inputs are obviously much better potential contributors of directional cues. Both the amplitude (Fig. 2) and the phase (Fig. 3) of the contralateral sounds change in opposite directions to the values for the ipsilateral sounds

when the sound source moves from one frontal direction to another. The change of phase is especially prominent and thus the most likely contributor to the directionality of the ear.

Transmission gains

The transmission gains from the contralateral tympanum and the two thoracic spiracles were measured in the following manner. A local sound source (described by Michelsen et al 1993a) was used for delivering sound at one of the auditory inputs, and walls of bees' wax between the auditory inputs ensured that the sound level at the other

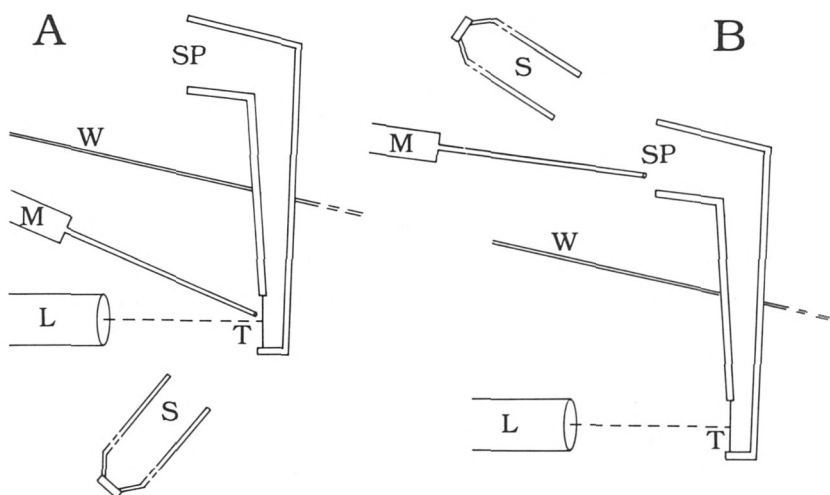

Fig. 4. Measuring the gain of a transmission path to the internal surface of the tympanum (T). A. The tympanal membrane is driven by sound at its external surface. B. The tympanal membrane is driven by sound arriving at its internal surface from the spiracular opening (SP) of the transmission path. L: laser vibrometer; M: probe-microphone; S: local sound source; W: wall made of bees' wax. Further explanation in the text.

inputs was at least 20 dB down (this was controlled by means of a probe microphone). We first determined the transfer function of the tympanum by applying sounds at its outer surface (Fig. 4A). The transfer function is the tympanal velocity divided by the sound pressure; it has an amplitude and a phase part. We then determined the transfer function for each route to the inner surface of the tympan-

um, but this time the sound was measured at the input in question (Fig. 4B). This transfer function consists of the gain of the transmission path times the transfer function of the tympanum. The gains of the transmission paths could then be obtained by dividing these transfer functions with the transfer function of the tympanum.

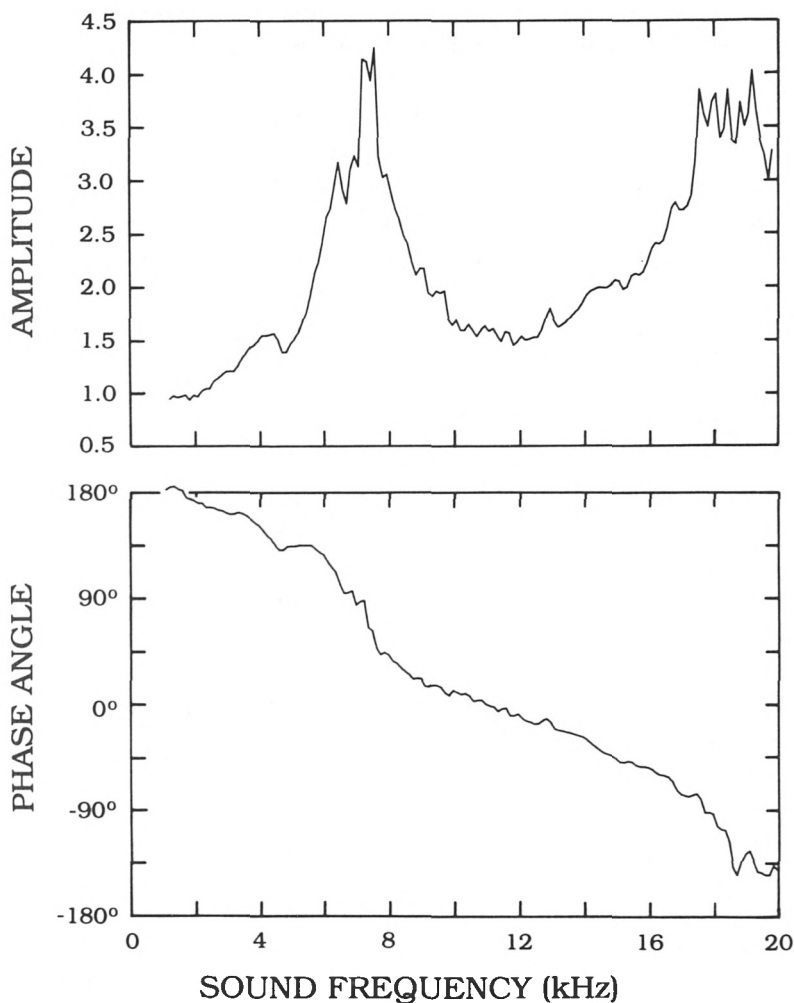

Fig. 5. The transmission gain for the sound arriving at the tympanum from the ipsilateral spiracle (IS). Note that the amplitude is plotted in a linear scale (not dB). An amplitude of 1 and a phase angle of 180° indicate that no change of amplitude or phase has taken place during the propagation of the sound.

The diffraction and time delays are determined by the size and external morphology of the body, and the values obtained from different individuals do not vary much. In contrast, we found a substantial inter-individual variation in the transmission gains. Furthermore, the cricket's auditory system is not always bilaterally symmetrical: substantial differences between the transmission gains and tympanal vibrations measured at the left and right side of the body are quite common.

For the transmission of sound from the *ipsilateral spiracle (IS)*, the amplitude gain is close to 1 at low frequencies and increases to reach a maximum around 6–8 kHz and again at 17–19 kHz (Fig. 5). At low frequencies the phase at the inner surface is close to that at the outer surface. With increasing frequency the sound at the inner surface becomes progressively delayed, as one would expect in a transmission line where the propagation of sound takes a certain time. The phase changes ca. 360° between 1 and 22 kHz. By assuming a propagation velocity of 344 m/s, the length of the tracheal tube can be calculated. The result (15.6 mm) is significantly larger than the actual length (ca. 12 mm). This means that the sound propagates with a lower velocity inside the tube than in the air outside the animal. The propagation velocity estimated from our data is 264 m/s. This value is in excellent agreement with that determined by Larsen (1981), who found an average value of 263 m/s by measuring the delays of very short impulse sounds. He pointed out that the determined value is rather close to that expected for isothermal wave propagation in air (245 m/s), and he suggested that an exchange of heat may occur at the tracheal walls.

The transmission of sound from the *contralateral spiracle (CS)* (Fig. 6) differs very much from this simple pattern. The amplitude is at a maximum at 5–7 kHz and again around 18 kHz (much like the sound from IS), but it is virtually zero below 3.5 kHz. In the frequency range 4–5 kHz (around the frequency of the calling song, which is at 4.6–4.7 kHz in *Gryllus bimaculatus*), the amplitude of the sound from CS varies drastically with frequency. Between 4 and 4.5 kHz the amplitude increases by a factor of 4. In some animals the increase levels off above 4.5 kHz, whereas in others the steep slope continues up to 4.75 kHz. The average increase between 4.75 kHz and 5 kHz is only 10%. The strong frequency dependence of the amplitude is

accompanied by a large change of phase. From 2 to 10 kHz the phase angle of the sound from CS decreases by approximately 800° (for comparison: the phase of the sound from IS shows a decrease of only 180°). Above 10 kHz the rate of decrease approaches that observed in the sound from IS.

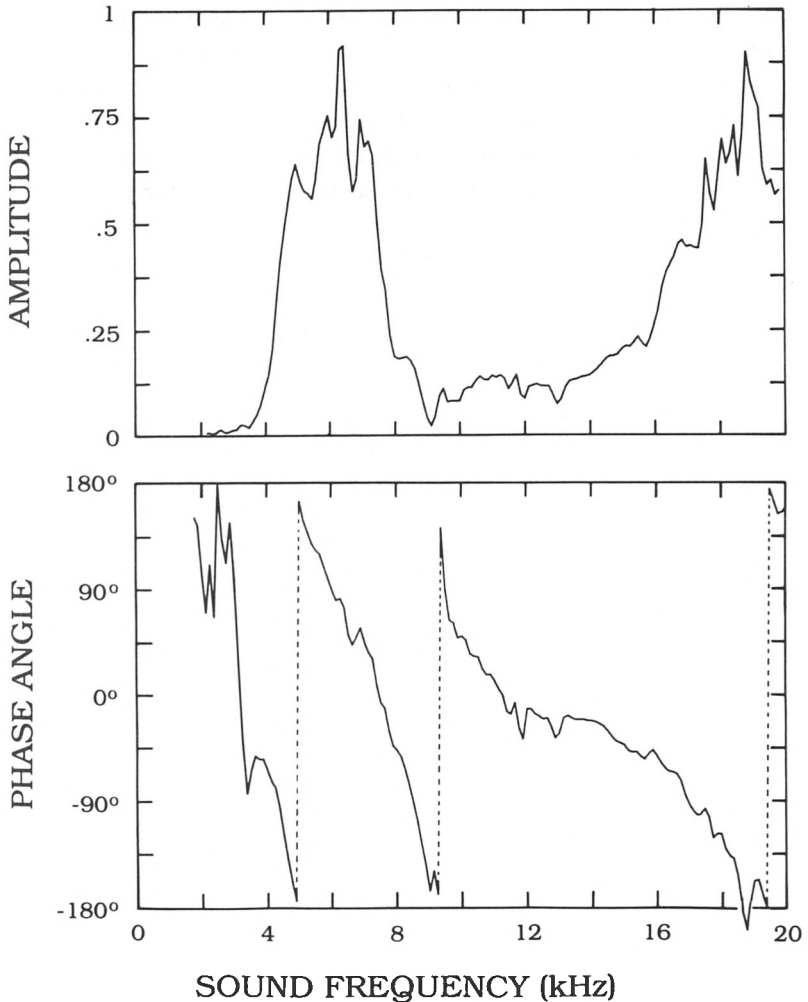

Fig. 6. The transmission gain for the sound arriving at the tympanum from the contralateral spiracle (CS). The phase curve is continuous, but has been cut at the position of the broken lines in order to save space.

The transmission from the *contralateral tympanum* (CT) follows the pattern observed in the transmission from CS. However, the amplitude of the sound arriving at the tympanum is considerably smaller.

The calculated and the measured directionality

The measured diffraction, time delays and transmission gains of the four sounds acting on the tympanum can now be combined in an attempt to account for the dependence of the tympanal vibrations on the direction of sound incidence. The calculations are fairly straightforward, but the large inter-individual variation in some of the data presents a problem. We decided to use averaged data for the diffrac-

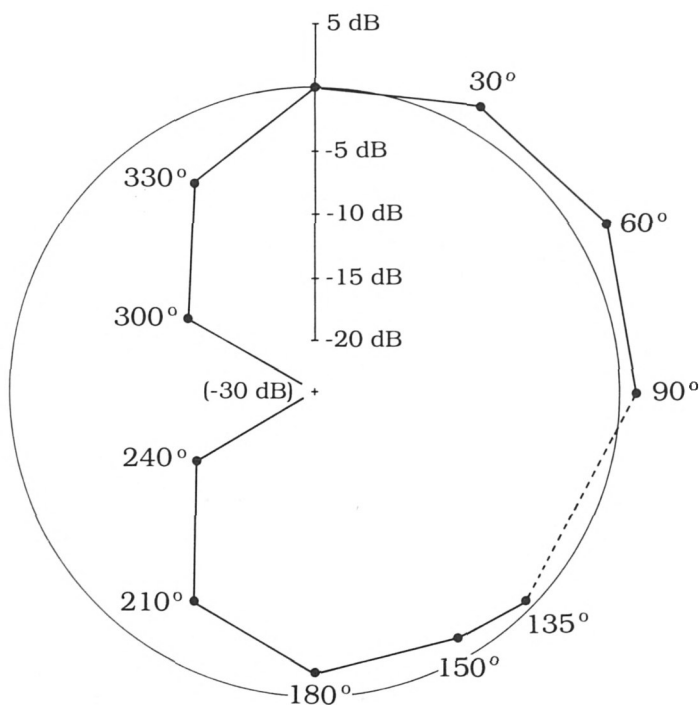

Fig. 7. The amplitude of vibration of the right tympanum, observed with laser vibrometry for 4.5 kHz sounds arriving from various directions. A deep (~ 30 dB) null is found at the contralateral (270°) direction of sound incidence. The dotted line indicates the position of the vibrometer. Note the slope of vibration amplitude in the forward direction (330° to 30°).

tion and time delays (these data show only moderate scatter). For the transmission gains we have chosen “typical” values for the amplitudes and varied the phase values within the ranges observed in the experiments. In this way we have obtained an impression of how robust the directional patterns are.

For frequencies up to and including 4.5 kHz, the amplitude gain of the transmission of sound from the contralateral tympanum (CT) is so small (below 0.1) that it does not have much effect on the directional pattern, with the possible exception of the magnitude of the “contralateral null” (the sensitivity of the ear is at a minimum for sounds arriving from the contralateral direction, see Fig. 7). In the following example at 4.5 kHz we ignore the sound from CT. The problem is then reduced to considering three vectors: the sound at

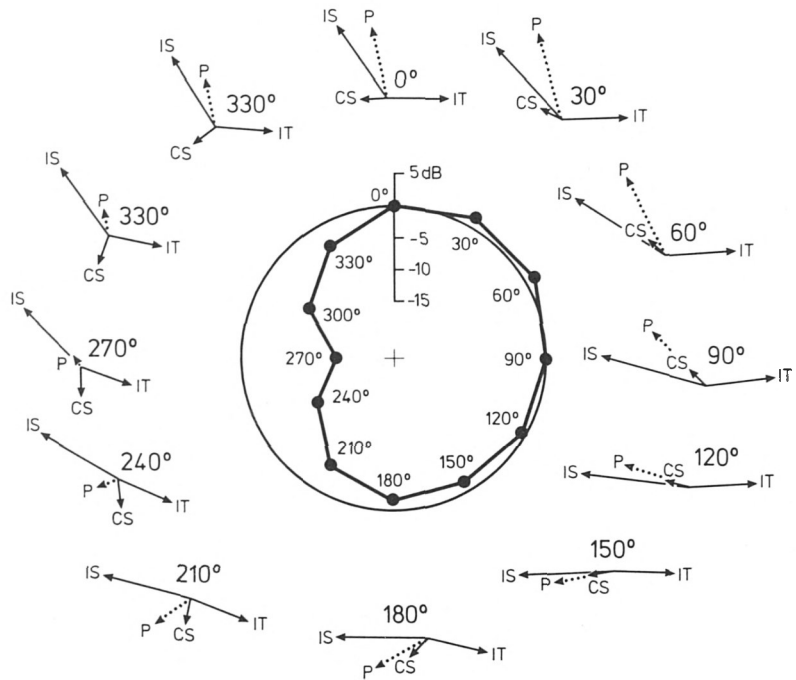

Fig. 8. Calculated directional pattern of the force acting on the tympanum of the right ear at 4.5 kHz. The force is proportional to a sound pressure, P , which is the sum of three vectors: the sound at the outer surface of the tympanum (IT) and the sounds transmitted to the inner surface from the ipsi- (IS) and contralateral (CS) spiracles. Compare the calculated directional pattern with the observed pattern in Fig. 7.

the outer surface of the tympanum (IT) and the sounds at the inner surface arriving from the ipsilateral and contralateral spiracles, respectively (IS and CS). The amplitude and phase of IT for sounds arriving from the frontal direction are, as a matter of definition, 1 and 0° . Typical values for the amplitude part of the transmission gain of the sounds from IS and CS are 1.5 and 0.44, respectively. Within the observed range of variation of phase angles of the transmission gains, we select the value 154° for the IS and 208° for CS. The first step in the calculation is to multiply the gain and the diffraction/time-of-arrival factor for each of the sound components and at each angle of sound incidence. The results are represented as three vectors, which are then added to produce a sound pressure (P), which is proportional to the force that causes the tympanum to vibrate. It should be noted that the phase angles for the transmission gains include a 180° phase shift, which means that in adding the three vectors, sound components acting on the inner surface (IS and CS) are subtracted from the sound component acting at the outer surface (IT).

The result of this model calculation is shown in Fig. 8. The directional pattern of the resultant pressure driving the ipsilateral tympanum is given by the solid curve. The polar plot is surrounded by the 12 vector diagrams. The calculated directional pattern has the most important of the features seen in the measured patterns (Fig. 7): The driving force is at a maximum at the ipsilateral directions 30° and 60° ; the force decreases by approximately 6 dB from 30° , through 0° to 330° ; and the force is at a minimum at 270° (the contralateral null).

When examining Fig. 8 one may start by looking at the vector diagram for the 270° direction. Obviously, the null is caused by the fact that the sum of CS and IT has approximately the same amplitude, but the opposite direction of IS. A deeper minimum (more perfect null) would only require a slight reduction in the amplitude of the sound from IS. One may now perform a consecutive examination of the vector diagrams for 300° , 330° , 0° and 30° . The amplitudes of the three vectors change only little, and only little variation is seen in the phase angles for IS and IT. The only major change is in the phase angle for CS. At 30° and 60° CS has almost the same phase as IS, and the amplitude of P is now at a maximum. We may conclude that *the slope of the driving force in the forward direction is caused almost entirely by changes in the phase angle of the sound from CS.*

Several directional diagrams have been calculated by selecting other values for IS and CS within the ranges observed during the measurements. The most conspicuous difference between the diagrams is in the magnitude and direction of the contralateral null, which is not always in the 270° direction. A closer examination of the data revealed that a change of sound frequency from 4.5 kHz towards 4 kHz causes the null to move backwards towards 240° or even 210° , whereas an increase of frequency from 4.5 towards 5 kHz causes the null to move forward towards 300° . This trend was, in fact, observed in directional diagrams of the tympanal vibrations measured with laser vibrometry during the collection of the data on diffraction/time-of-arrival.

Despite these variations in the position of the null, the slope of driving force in the forward directions remained large and robust towards reasonable variations in the parameters used in the calculations. Only in a few cases where very extreme parameters were used did the slope decline below a 4–5 dB difference between the amplitudes in the 30° and 330° directions of sound incidence. Therefore, the variations in the transmission gains and directional patterns do not seem to have any important effects on the ability of the animals to locate singing crickets in the forward direction. This conclusion is confirmed by the measured directionality diagrams, where the vibration amplitude at 30° sound direction was always approximately 2 dB above that at 0° . Around 4.5 kHz the amplitude at 330° was generally 5–6 dB below that at 0° , but larger differences were also observed. The slope of amplitude in the forward directions was less prominent at 4 and 5 kHz than at 4.5 kHz.

In summary, despite the large variations in the shapes of the measured and calculated directional patterns, the biologically important forward slope was very consistent. Furthermore, the same tendency for the position of the minimum to move with frequency was observed in both measured and calculated patterns. Although not enough animals were included in the experimental part of this study to allow us to detect systematic differences between experimental and calculated results, we conclude that the measured data on transmission, diffraction and time delays can account for the most prominent features of the directivity.

Further aspects and some unsolved problems

For many years, a large number of investigators, including ourselves, have tried to obtain evidence for the magnitude of sound transmission to the inner surface of the tympanum by blocking possible sound inputs and observing the effects on the ear. This is a dubious strategy, since blocking may affect not only the sound transmission, but also the mechanics of the ear (by changing the radiation impedance of the tympanum). A change of membrane impedance was in fact observed when we blocked the ipsilateral spiracle while measuring the tympanal vibrations caused by sound at the external surface of the tympanum. With the blocking approach the investigator is therefore trying to solve one equation with two variables. In the cricket, this popular approach would lead to quite misleading conclusions, and this is probably true for other animals as well.

In the cricket, the conditions for creating a useful directionality in the forward directions are fulfilled around the frequency of the calling song, but not necessarily at other frequencies. A tuning of phonotaxis to frequencies around the calling song has been reported by Hill (1974), Popov et al (1975), Boyd and Lewis (1983) and others. It remains to be learned how crickets localize sounds at other frequencies.

In some other animals, the sound amplitude at the outer and inner surface of the tympanum may not match. This is true in many birds where the amplitude of the sound arriving at the inner surface of the tympanum is too small to enhance binaural cues significantly (Klump and Larsen 1992). The opposite situation is found in many bushcrickets, where the directionality is determined almost entirely by the large internal sound pressure (Michelsen et al. 1993a).

It is obvious from Fig. 8 that the slope of sensitivity in the forward directions depends upon a change in the relative phase angles of three vectors. The sound from the contralateral spiracle (CS) plays a prominent role in creating this directionality. The sound from the ipsilateral spiracle (IS) is necessary, however, for producing the cardioid pattern (a pressure difference receiver with only the external sound and the sound from CS would produce a figure-of-eight pattern which would not provide a useful slope in the forward direction). In

many animals, the investigators have proposed pressure difference mechanisms with only two sound components (one acting on the outer surface and one on the inner surface). It remains to be learned how such systems operate.

Acknowledgements

Original research for this chapter was supported by grants from the Danish Natural Science Research Council. The author is most grateful to Lee A. Miller for his comments on the manuscript.

References

- Autrum H. (1940). Über Lautäußerungen und Schallwahrnehmung bei Arthropoden. II. Das Richtungshören von *Locusta* und Versuch einer Hörtheorie für Tympanalorgane vom Locustidentyp. *Z. vergl. Physiol.* 28: 326–352.
- Boyd P., Lewis B. (1983). Peripheral auditory directionality in the cricket (*Gryllus campestris* L., *Teleogryllus oceanicus* Le Guillou). *J comp Physiol* 153: 523–532.
- Brownell P., Farley RD (1979). Orientation to vibrations in sand by the nocturnal scorpion *Paruroctonus mesaensis*: mechanisms of target localization. *J comp Physiol* 131: 31–38.
- Fletcher NH and Thwaites S. (1979). Acoustical analysis of the auditory system of the cricket *Teleogryllus commodus* (Walker). *J Acoust Soc Am* 66: 350–357.
- Helversen D. von, Helversen O. von (1983) Species recognition and acoustic localization in acridid grasshoppers: a behavioural approach. In: Huber F., Markl H. (eds) *Neuroethology and Behavioral Physiology*. Springer Verlag, Berlin, Heidelberg. pp 95–107.
- Hergenröder R., Barth FG (1983) Vibratory signals and spider behaviour: How do the sensory inputs from the eight legs interact in orientation? *J comp Physiol* 152: 361–371.
- Hill KG (1974). Carrier frequency as a factor in phonotactic behaviour of female crickets *Teleogryllus commodus*. *J comp Physiol* 93: 7–18.
- Hill KG and Boyan GS (1976). Directional hearing in crickets. *Nature* 262: 390–391.
- Hill KG, Lewis B., Hutchings ME, Coles RB (1980) Directional hearing in the Japanese quail. I. Acoustic properties of the auditory system. *J exp Biol* 86: 135–151.
- Kleindienst H-U (1978). Schallbeugung und -reflexion am Grillenkörper im Frequenzbereich 5–20 kHz. *Verh. Dtsch. Zool. Ges.* 1978: 160.
- Klump GM and Larsen ON (1992). Azimuthal sound localization in the European starling (*Sturnus vulgaris*): I. Physical binaural cues. *J comp Physiol A* 170: 243–251.
- Larsen ON (1981). Mechanical time resolution in some insect ears. II. Impulse sound transmission in acoustic tracheal tubes. *J comp Physiol* 143: 297–304.

- Larsen ON, Michelsen A. (1978). Biophysics of the Ensiferan ear. III. The cricket ear as a four-input system. *J comp Physiol* 123: 219–227.
- Lewis B. (1983). Directional cues for auditory localization. In: Lewis B. (ed) *Bioacoustics, a comparative approach*. Academic Press London. pp 233–257.
- Michelsen A. (1971) The physiology of the locust ear. *Z vergl Physiol* 71: 49–128.
- Michelsen A., Hedwig B., Elsner N. (1990) Biophysical and neurophysiological effects of respiration on sound reception in the migratory locust *Locusta migratoria*. In: Gribakin FG, Wiese K., Popov AV (eds) *Sensory systems and communication in Arthropods*. Birkhäuser Verlag, Basel, Boston, Berlin, pp. 199–203.
- Michelsen A., Heller K-G, Stumpner A. and Rohrseitz K. (1993a). The gain of the acoustic trachea in bushcrickets, determined with a new method. *J comp Physiol*.
- Michelsen A., Popov AV, Lewis B. (1993b). Physics of directional hearing in the cricket *Gryllus bimaculatus*. *J comp Physiol*.
- Payne R., Roeder KD, Wallman J. (1966) Directional sensitivity of the ears of noctuid moths. *J exp Biol* 44: 17–31.
- Popov AV, Shuvalov VF and Markovich AM (1975). Spectrum of the calling songs, phonotaxis and the auditory system in the cricket *Gryllus bimaculatus* de Geer. *J evol Bioch Fiziol* (in Russian) 11: 453–460.
- Schmitz B., Scharstein H., Wendler G. (1983). Phonotaxis in *Gryllus campestris* L. (Orthoptera, Gryllidae). II. Acoustic orientation of female crickets after occlusion of single sound entrances. *J comp Physiol* 152: 257–264.
- Weber T. and Thorson J. (1989). Phonotactic behavior of walking crickets. In: *Cricket behavior and neurobiology* (F. Huber, TE Moore and W. Loher, eds). Cornell Univ Press, p. 310–339.
- Tautz J. (1979) Reception of particle oscillation in a medium – an unorthodox sensory capacity. *Naturwiss* 66: 452–461.